



## PM080-115-1225BT-4 PM080-230-1225BT-4

### Features

Size:	120 x 120 x 25 mm (4.7" x 4.7" x 1.0")
Airflow:	80 CFM
Weight:	338 grams (12 oz)
Noise:	45 dBA
Terminal:	.120 inches
Impeller:	Reinforced Plastic (94V-0)
Frame:	Aluminum Alloy
Bearings:	Sealed Ball



UL E101153



CUL E101153

• RoHS Compliant

### Dimensions – inches mm

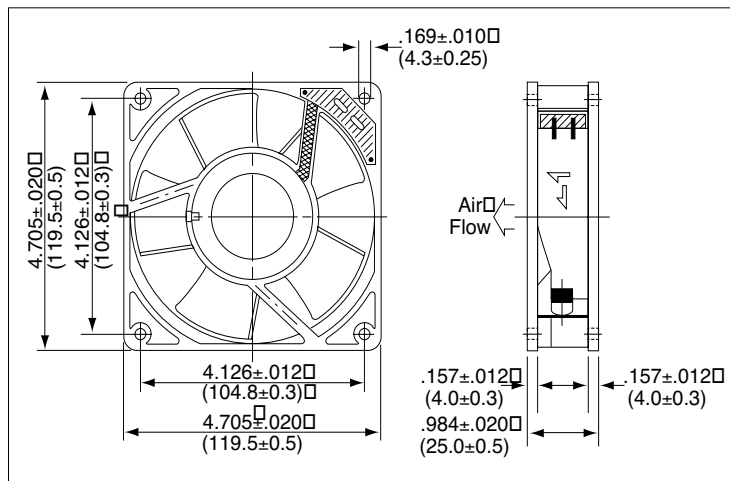

### Air Flow vs Air Pressure

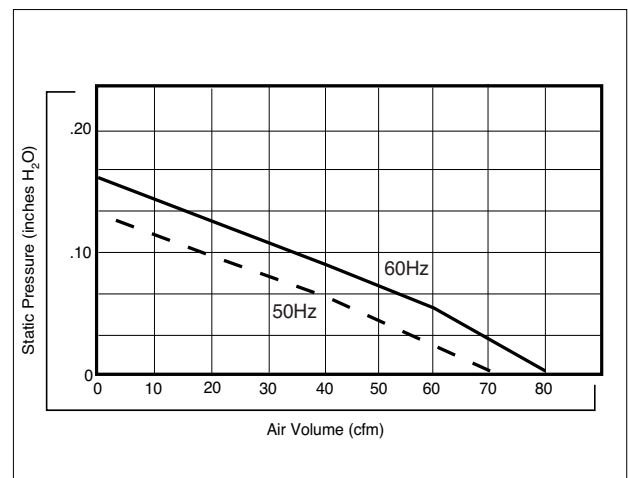

### Performance

Type	Rated Voltage (V)	Operating Frequency (Hz)	Input Power (W) (@ 60 Hz)	Max Air Flow (CFM)	Max Air Pressure (In H <sub>2</sub> O)	Noise* (dBA)	Operating Temperature (°C)	Life Expectancy (Hr) (@ 20 ±15°C)
PM080-115-1225BT-4	115	50/60	18.0	80	0.16	45	-20~ +85	60,000
PM080-230-1225BT-4	230	50/60	18.0	80	0.16	45	-20~ +85	60,000

\*Measured 1 m from intake

Product specifications contained herein may be changed without prior notice.

It is therefore advisable to contact Purdy Electronics before proceeding with the design of equipment incorporating this product.